

# ***USER'S MANUAL***

***FA120C Security System***

---



N5100-3V3 9/96

# TABLE OF CONTENTS

<b>SYSTEM OVERVIEW</b> .....	4
Keypads .....	4
Zones.....	4
Alarms.....	5
Fire Protection.....	5
Burglary Protection .....	5
Memory of Alarm.....	5
Pager Notification .....	5
<b>ABOUT THE KEYPADS</b> .....	6
Keypad Types .....	6
Keypad Styles .....	6
<b>SUMMARY OF SYSTEM STATUS DISPLAYS</b> .....	7
<b>SUMMARY OF KEYPAD FUNCTIONS</b> .....	8
<b>SECURITY CODES</b> .....	10
Duress Code.....	10
Quick Arming .....	10
Assigning/Changing/Deleting User Codes (Using the <span style="border: 1px solid black; padding: 0 2px;">8</span> CODE Key).....	11
<b>ENTRY/EXIT DELAYS</b> .....	12
<b>CHECKING FOR OPEN ZONES</b> (Using the <span style="border: 1px solid black; padding: 0 2px;">*</span> READY Key).....	13
<b>BYPASSING PROTECTION ZONES</b> .....	14
Using The <span style="border: 1px solid black; padding: 0 2px;">6</span> BYPASS Key .....	14
Quick Bypass .....	15
<b>ARMING PERIMETER ONLY, WITH ENTRY DELAY ON</b> (Using The <span style="border: 1px solid black; padding: 0 2px;">3</span> STAY Key) .....	16
<b>ARMING PERIMETER ONLY, WITH ENTRY DELAY OFF</b> (Using The <span style="border: 1px solid black; padding: 0 2px;">7</span> INSTANT Key ) .....	17
<b>ARMING ALL PROTECTION, WITH ENTRY DELAY ON</b> (Using The <span style="border: 1px solid black; padding: 0 2px;">2</span> AWAY Key) .....	18
<b>ARMING ALL PROTECTION, WITH ENTRY DELAY OFF</b> (Using The <span style="border: 1px solid black; padding: 0 2px;">4</span> MAXIMUM Key) .....	19

(continued)

## TABLE OF CONTENTS

<b>DISARMING THE SYSTEM AND SILENCING ALARMS</b> (Using the <b>1</b> OFF Key).....	20
<b>USING THE KEYSWITCH</b> .....	21
<b>CHIME MODE</b> (Using the <b>9</b> CHIME Key) .....	22
<b>PANIC KEYS</b> .....	22
<b>TESTING THE SYSTEM</b> (Using the <b>5</b> TEST Key) .....	24
<b>TROUBLE CONDITIONS</b> .....	26
"Check" and "Battery" Displays .....	26
Power Failure .....	27
Other Displays .....	28
<b>FIRE ALARM SYSTEM, IF INSTALLED</b> .....	29
In Case of Fire Alarm.....	29
Silencing Fire Alarms .....	30
<b>NATIONAL FIRE PROTECTION ASSOCIATION RECOMMENDATIONS ON SMOKE DETECTORS</b> .....	31
<b>EMERGENCY EVACUATION</b> .....	32
<b>QUICK GUIDE TO ALARM SYSTEM FUNCTIONS</b> .....	33
<b>SUMMARY OF AUDIBLE/VISUAL NOTIFICATIONS</b> .....	34
<b>PROTECTION ZONES LIST</b> .....	35
<b>OWNER'S INSURANCE PREMIUM CREDIT REQUEST</b> .....	37
<b>CANADIAN DEPARTMENT OF COMMUNICATIONS (DOC) STATEMENT</b> .....	39
<b>FEDERAL COMMUNICATIONS COMMISSION (FCC) STATEMENTS</b> .....	40
<b>IN THE EVENT OF TELEPHONE OPERATIONAL PROBLEMS</b> .....	41
<b>THE LIMITATIONS OF THIS ALARM SYSTEM</b> .....	42
<b>SERVICING INFORMATION</b> .....	43
<b>WARRANTY</b> .....	Back Cover

This manual is a step-by-step guide that will acquaint you with the system's features and benefits. It defines the components and their functions, describes their operation, and instructs you with normal and emergency procedures. Keep this manual in a convenient place so that you can refer to it as necessary.

## **SYSTEM OVERVIEW**

- General** Congratulations on your ownership of a First Alert Professional Security System. You've made a wise decision in choosing it, for it represents the latest in security protection technology today, including microcomputer technology to monitor all system status.
- Basically, this system offers you three forms of protection: burglary, fire and emergency. Your system may consist of at least one keypad which provides full control of system operation, plus various devices such as door and window sensors and motion detectors. It may also include a selected number of smoke or combustion detectors designed to provide early warning in case of fire. Your system may also have been programmed to automatically transmit alarm or status messages over the phone lines to a central alarm monitoring station.
- Keypads** Your keypads allow you to control all system functions and feature a telephone style (digital) keypad and a Liquid Crystal Display (LCD) that shows the nature and location of all occurrences and a built-in sounder which sounds during alarms and troubles.
- For additional information, see the following section: *ABOUT THE KEYPADS*.
- Zones** Your system's sensing devices have been assigned to various "zones". For example, the sensing device on your Entry/Exit door may have been assigned to zone 01, sensing devices on windows in the master bedroom to zone 02, and so on. These zone numbers will appear on the display when an alarm or trouble condition occurs.

(continued)

## **SYSTEM OVERVIEW**

- Alarms** When an alarm occurs, both the keypad and external sounders will sound, and a message at the keypad will identify the zone(s) causing the alarm. In addition, if your system is connected to a central monitoring station, an alarm message will be sent. To stop the alarm sounding, you simply disarm the system.
- Fire Protection** The fire protection portion of your security system (if used) is always on and will sound an alarm if a fire condition is detected. Refer to the *FIRE ALARM SYSTEM* section for important information concerning fire protection, smoke detectors and planning emergency exit routes from your premises.
- Burglary Protection** The burglary protection portion of your system must be turned on or "armed" before it will sense burglary alarm conditions and sound an alarm. Your system can be armed in one of four modes: STAY, AWAY, INSTANT and MAXIMUM. Refer to the *ARMING THE SYSTEM* sections for instructions in using these modes of operation.  
Your system also provides a CHIME mode for alerting you to the opening and closing of doors and windows while the system is disarmed.
- Memory Of Alarm** When an alarm or trouble condition occurs, the keypad displays the number(s) of the zone(s) that caused the problem, and displays the type of alarm or trouble (ex. FIRE, ALARM, CHECK). The display remains until it is cleared by entering the OFF sequence (security code + **OFF** key) twice.
- Pager Notification** If the paging feature has been programmed for your system, a pager will respond to certain conditions as they occur in your system, and display code numbers indicating the type of condition that has occurred, as follows:
- |                |              |
|----------------|--------------|
| 1811 = Trouble | 1911 = Alarm |
| 1001 = Open    | 1002 = Close |
- Check with your installer for additional information.

## ABOUT THE KEYPADS

**Keypad Types** All commands and procedures described herein are illustrated for Fixed-Word Display keypads, however, an Alpha Display keypad (with a 2-line LCD display for more detailed protection point identification and system status, but with similar commands and procedures) is available and might have been used instead.

**Keypad Styles** Fixed-Word keypads are available in two styles, A and B, either of which may have been used in your system. Although different in appearance, both styles are functionally similar. The keypads on style B keypads are located behind a flip-down door which can be removed, if desired. Words displayed on all Fixed-Word keypads are the same, except that their location in the display window differs slightly with each style.

*Unless noted otherwise, all procedures in this manual apply equally to all keypad types and styles.*

**Note:** Style B keypads are equipped with a READY indicator in place of the POWER indicator on style A keypads. The READY indicator is lit when the system is ready for arming (no protection zones open). While the system is disarmed, this indicator will go on and off as protection zones are opened and closed.

**STYLE A FIXED-WORD KEYPADS**

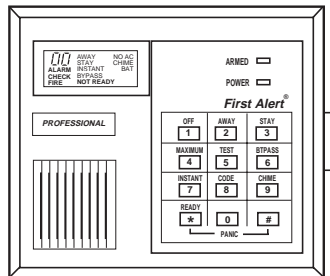

FA200KP

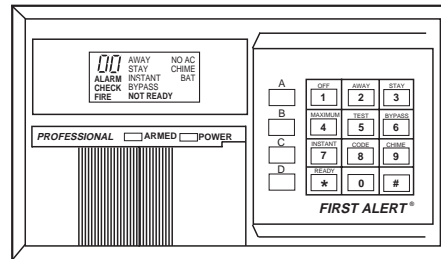

FA310KP

**STYLE B FIXED-WORD KEYPAD**

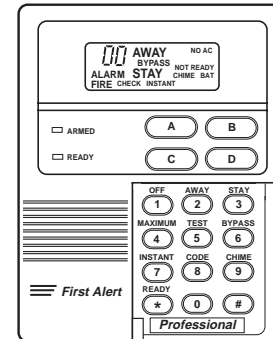

FA250KP  
(KEYPAD  
DOOR  
REMOVED)

## SUMMARY OF SYSTEM STATUS DISPLAYS

- AWAY** All burglary zones, interior & perimeter, are armed.
- STAY** Perimeter burglary zones, such as windows and doors are armed.
- INSTANT** Perimeter burglary zones armed and entry delay is turned off.
- BYPASS** One or more burglary protection zones have been bypassed.
- NOT READY** Appears when burglary portion of the system is not ready for arming (due to one or more open protection zones).
- READY** The burglary portion of the system is ready to be armed.
- NO AC** Appears when AC power has been cut off. System is operating on backup battery power.
- AC** Appears when AC power is present.
- CHIME** Appears when the CHIME feature is ON.
- BAT** Low system battery (if no zone number is shown), or Low battery condition in a wireless sensor (if zone number is *also* shown).
- ALARM** Appears when an intrusion has been detected and the system is armed (also appears during a Fire alarm). Accompanied by the ID # of the zone in alarm.
- CHECK** Appears when a malfunction is discovered in the system at any time or if a fault is detected in a FIRE zone at any time or in a DAY(Trouble)/NIGHT(Alarm) burglary zone during a disarmed period. Accompanied by a display of zone number in trouble.
- FIRE** Appears when a fire alarm is present. Accompanied by a display of the zone # in alarm.

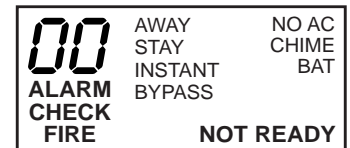

**STYLE A KEYPAD DISPLAY**

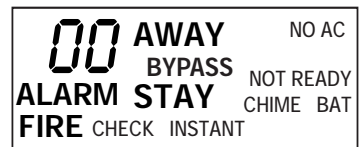

**STYLE B KEYPAD DISPLAY**

## SUMMARY OF KEYPAD FUNCTIONS

1. **DISPLAY WINDOW:** Displays protection zone ID and system status messages.
  2. **1 OFF KEY†:** Disarms burglary portion of the system, silences alarms and audible trouble indicators, and clears visual display after problem's correction.
  3. **2 AWAY KEY†:** Arms the entire burglary system, perimeter and interior.
  4. **3 STAY KEY†:** Arms perimeter portion of burglary system only. Interior protection is not armed, which allows movement within premises without causing alarm.
  5. **4 MAXIMUM KEY†:** Arms in manner similar to AWAY mode, but without the entry delay feature, thus providing maximum protection. An alarm will occur immediately upon opening any protection point, including the main door.
  6. **5 TEST KEY†:** Tests the system and alarm sounder if disarmed. Refer to *TESTING THE SYSTEM* section for test procedures.
  7. **6 BYPASS KEY†:** Removes individual protection zones from being monitored by the system.
  8. **7 INSTANT KEY†:** Arms in manner similar to STAY mode, but without the entry delay feature. Entering via the main door will cause an instant alarm.
  9. **8 CODE KEY†:** Used to assign additional user codes for other users of the system.
  10. **9 CHIME KEY†:** Turns CHIME mode on and off. When on, the opening of windows or doors while the system is disarmed will sound 3 beeps at the keypad(s).
  11. **\* READY KEY:** Displays all open protection zones.
  12. **# KEY:** "Quick Arm" key permits ARMING of the system without use of a security code (if so programmed).
  13. **KEYS 0–9:** Used to enter your security code(s).
  14. **READY INDICATOR:** (GREEN) Lit when the system is ready to be armed (no faults present). While the system is disarmed, this indicator will go on and off as protection zones are closed and opened.  
**Note:** On some keypads (Style A) there is, instead, a **POWER INDICATOR** (GREEN) which is lit when AC power is present. If the indicator is off, the system may still be operating, but on its backup battery power. See *Power Failure* in *TROUBLE CONDITIONS* section.
- †Note:* Keys **1** through **9** each perform their associated companion functions (*OFF, AWAY, STAY, etc.*) when preceded by an entry of the security code (as described later).



15. **ARMED INDICATOR:** (RED).  
Lit when the system has been armed (STAY, AWAY INSTANT or MAXIMUM).
16. **INTERNAL SOUNDER:**  
The built-in keypad sounder mimics the alarm sounder during alarms, and will also "beep" during certain system functions. (see *SUMMARY OF AUDIBLE/ VISUAL NOTIFICATION*).
17. **EMERGENCY KEYS:**  
Individual keys **A**, **B**, and **C** (key D not used).  
On some keypads, these keys are not present, and the following key pairs may be available, instead, for emergency functions:  
\* & # , \* & 1 , # & 3
- Some or all of these keys/pairs may be programmed for panic functions by your installer (see *PANIC KEYS* section).

**IMPORTANT!:**  
When entering codes and commands, sequential key depressions must be made within 2 seconds of one another. If 2 seconds elapses without a key depression, the entry is aborted and must be repeated from its beginning.

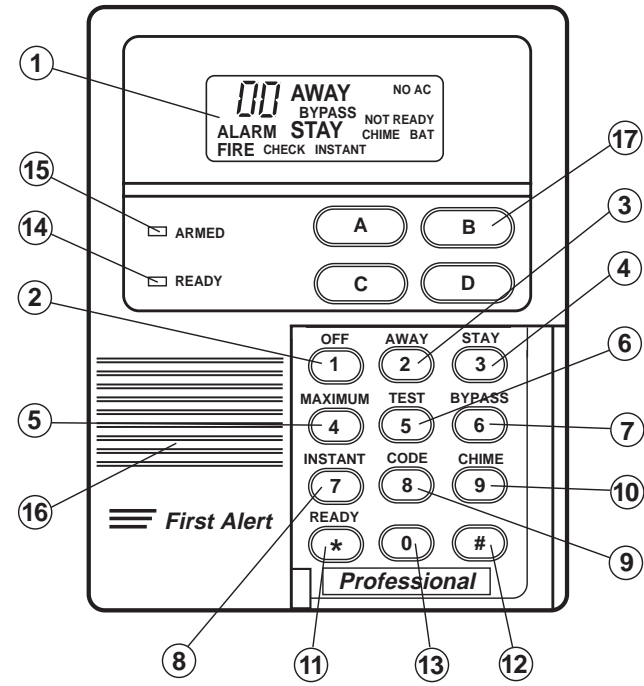

**STYLE B KEYPAD**

## SECURITY CODES

**General** At the time of installation, your installer programmed a personal four-digit Master code, known only to you and yours. This code is used to perform most system functions, including arming and disarming of the system. As an additional safety feature, temporary user codes can be assigned (see next page) for use by those not having a need to know the Master code. Note that the Master code remains in effect even when other user codes are assigned.

### Duress Code

Ask your installer if "Duress" is active for your system, and if so, check here:

This feature is intended for use when you are forced to disarm or arm the system under threat. When used, the system will act normally, but can silently notify the central station of your situation, if that service has been provided.

The Duress code is defined as user number 8.

**Important:** The Duress code is useful only when connected to a central station.

### Quick Arming

Ask your installer if "Quick Arming" is active for your system, and if so, check here:

If your system supports "Quick Arming", the "#" key can be pressed in place of the security code when arming the system. The security code is *always* required, however, when disarming the system.

## SECURITY CODES

### To Assign, Change, or Delete User Codes

#### 4-DIGIT USER CODES

It is recommended that obvious codes such as 1 1 1 1 or 1 2 3 4 not be assigned.

#### Important:

Temporary users should not be shown how to use any system function they do not need to know (e.g., bypassing protection zones).

1. Enter your Master code and press the **CODE** key.
2. Enter single-digit User Number (2–7) for which a code is to be assigned, changed, or deleted.
3. **If assigning or changing a user's code**, enter the desired 4-digit code for use by that User Number. The keypad will beep once. **If deleting a user's code**, perform steps 1 & 2 and stop. In a few moments the keypad will beep once, indicating that the existing code has been deleted.

**To assign your Duress code**, do the following:

Enter your [Master code] + [8] + [8] + [desired 4-digit code]. The keypad will beep once.

**The Master code can be changed** by the main user of the system. To change it, do the following:

Enter your [Master code] + [8] + [1] + [new Master code] + [new Master code] again. The keypad will beep once.

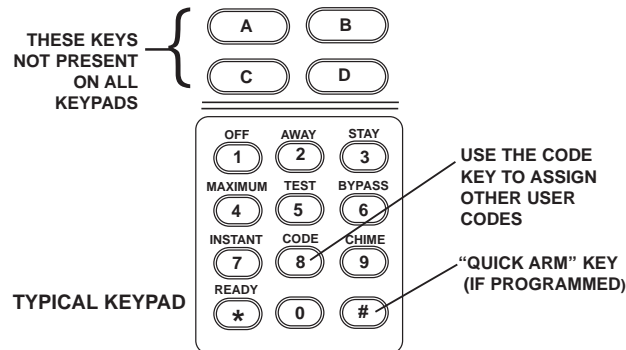

## ENTRY/EXIT DELAYS

### General Information

Your system has preset time delays, known as exit delay and entry delay. When you arm your system, **exit delay** gives you time to leave through the main door without setting off an alarm. **Entry delay** gives you time to disarm the system when you reenter through the main door. The system must be disarmed, however, before the entry delay period ends, or an alarm will occur. The keypad will beep slowly during the entry delay period, reminding you to disarm the system.

You can also arm the system with no entry delay at all by using either INSTANT or MAXIMUM arming modes. These modes can provide greater security while you are sleeping or while you are away for extended periods of time.

See your installer for your delay times and record them here:

**Exit Delay:**  seconds

**Entry Delay:**  seconds

# CHECKING FOR OPEN ZONES

**Using the \*** **READY Key** Before your system can be armed, all protected doors, windows and other protection zones must be closed or bypassed (see *BYPASSING PROTECTION ZONES* section), otherwise the keypad will display a "Not Ready" message, and if your keypad has a READY indicator light, it will not be lit. The **READY** key can be used to display all faulted zones, making it easier for you to secure any open zone.

To display faulted zones, simply press and release the **READY** key (do not enter code first). Secure or bypass the zones displayed before arming the system.

A "Ready" message will be displayed when all protection zones have been either closed or bypassed and the keypad's READY indicator light (if present) will be lit.

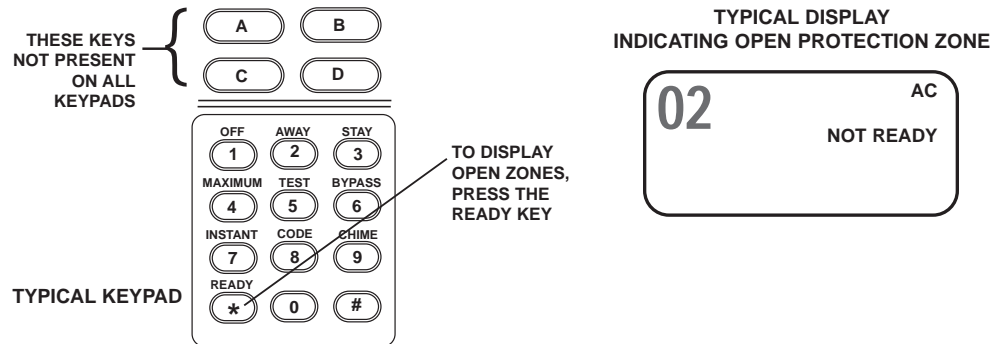

# BYPASSING PROTECTION ZONES

## 6 Using the BYPASS Key

**LIMITATION**  
The system will not allow fire zones to be bypassed.

All bypasses are removed when an OFF sequence (security code plus OFF) is performed.

This key is used when you want to arm your system with one or more zones intentionally unprotected. The system must be disarmed first.

1. Enter your security code and press the **BYPASS** key.
2. Enter zone number(s) for the zone(s) to be bypassed (e.g., 06, 10, 13, etc.). *Single digit zone numbers must be preceded by a zero (e.g. 05, 06).*
3. When finished, the keypad will display a "Bypass" message along with each bypassed zone number, accompanied by a beep for each. Wait for these zones to be displayed, to confirm their bypass.
4. Arm the system as usual.

**Bypassed zones are unprotected and will not cause an alarm if violated while your system is armed.**

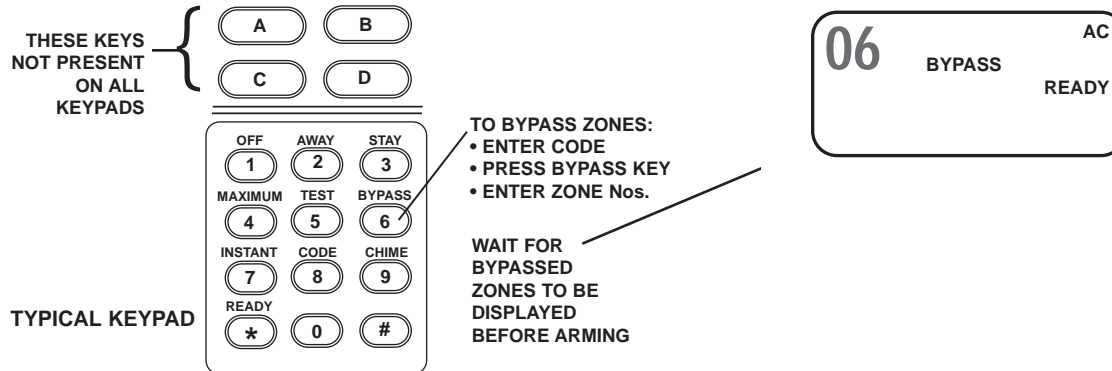

## BYPASSING PROTECTION ZONES

### Quick Bypass

Ask your installer if "Quick Bypass" is active for your system, and if so, check here:

If your system supports "Quick Bypass", it allows you to automatically bypass all open (faulted) zones without having to enter zone numbers individually.

To use this feature, enter your security code, press the **BYPASS** key, then stop. In a few moments, all open zones will be displayed along with a "Bypass" message. Wait for all bypassed zones to be displayed, then arm the system as usual.

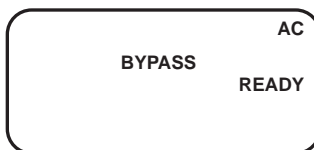

THE SYSTEM CAN  
NOW BE ARMED WITH  
ZONES BYPASSED

# ARMING PERIMETER ONLY

## WITH ENTRY DELAY ON

### 3 Using the STAY Key

**BEFORE ARMING**  
close all doors and windows  
(see *CHECKING FOR OPEN ZONES* on page 13).

Use this key when you are staying inside, but expect someone to use an entry/exit door later.

1. Enter your security code and press the **STAY** key.
2. The keypad beeps three times and displays the armed message. The red ARMED indicator lights.
3. The system arms. An alarm sounds immediately if a protected perimeter window or non-entry/exit door is then opened, but you may otherwise move freely throughout the premises.

**Later arrivals can enter through an entry/exit door without causing an alarm, but they must disarm the system within the entry delay period to avoid sounding an alarm.**

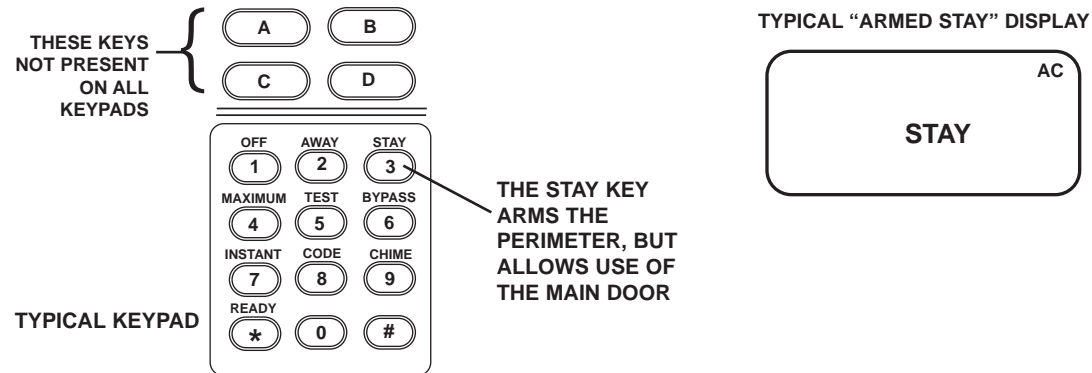



# ARMING PERIMETER ONLY

WITH ENTRY DELAY OFF

Using the **7** INSTANT Key

**BEFORE ARMING**  
close all doors and windows  
(see *CHECKING FOR OPEN ZONES* on page 13).

Use this key when you are staying inside and do not expect anyone to use an entry/exit door.

1. Enter your security code and press the **INSTANT** key.
2. The keypad beeps three times and displays the armed message. The red ARMED indicator lights.
3. The system arms. An alarm sounds immediately if any protected perimeter door or window is then opened, but you may otherwise move freely throughout the premises.

**An alarm sounds immediately if anyone opens an entry/exit door.**

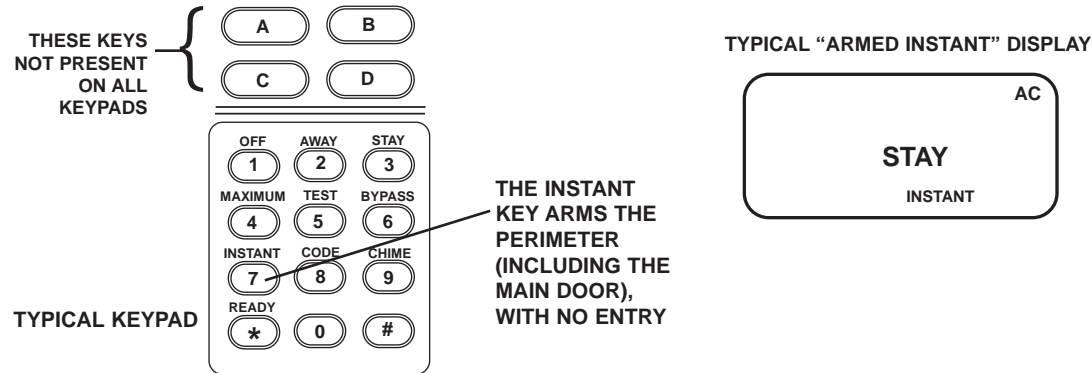

# ARMING ALL PROTECTION

## WITH ENTRY DELAY ON

**2** Using the **AWAY Key**

**BEFORE ARMING**  
close all doors and windows  
(see *CHECKING FOR OPEN ZONES* on page 13).

**Use this key when no one will be staying inside.**

1. Enter your security code and press the **AWAY** key.
2. The keypad beeps twice and displays the armed message. The red ARMED indicator lights.
3. You may leave through an entry/exit door during the exit delay period without causing an alarm.

After exit delay, the system arms and sounds an alarm if a protected window or non-entry/exit door is then opened, or if any movement is detected inside your premises.

**You may reenter through an entry/exit door, but must disarm the system within the entry delay period to avoid an alarm.**

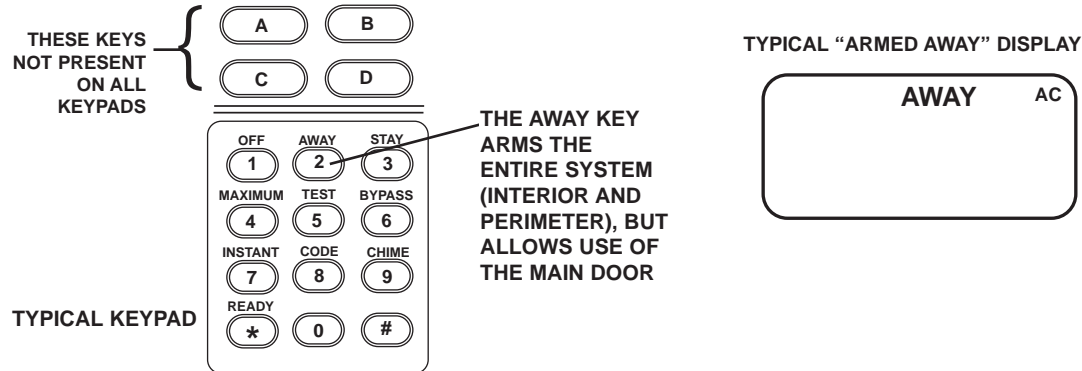

# ARMING ALL PROTECTION

## WITH ENTRY DELAY OFF

### 4 Using the MAXIMUM Key

**BEFORE ARMING**  
close all doors and windows  
(see *CHECKING FOR OPEN ZONES* on page 13).

Use this key when the premises will be vacant for extended periods of time such as vacations, etc., or when retiring for the night and no one will be moving through protected interior areas.

1. Enter your security code and press the **MAXIMUM** key.
2. The keypad beeps twice and displays the armed message. The red ARMED indicator lights.
3. You may leave through an entry/exit door during the exit delay period without causing an alarm.

After exit delay, the system arms and sounds an alarm immediately if any protected door or window is opened, or if any movement is detected inside your premises.

**An alarm sounds immediately, when someone reenters.**

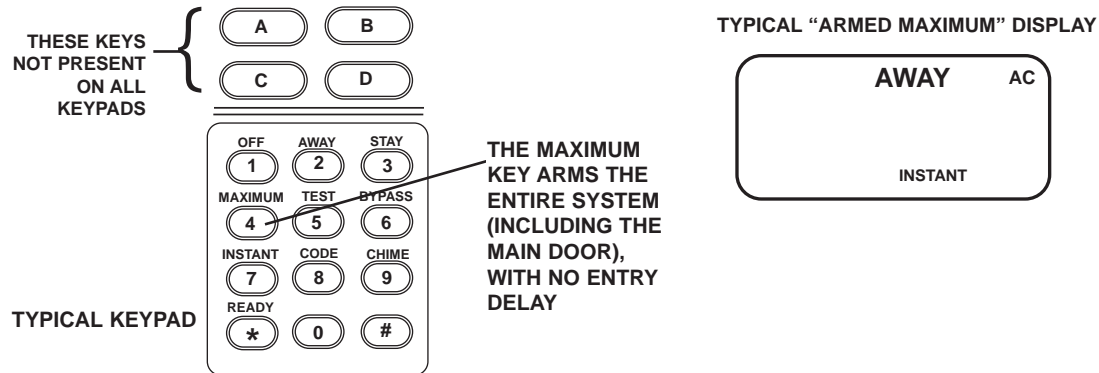

# DISARMING THE SYSTEM AND SILENCING ALARMS

Using the

**1** OFF Key

**IMPORTANT:**  
If you return and the main burglary sounder is on:

DO NOT ENTER, but CONTACT THE POLICE from a nearby safe location.

If you return after an alarm has occurred and the main sounder has shut itself off:

the keypad will beep rapidly upon your entering, indicating that an alarm has occurred during your absence (the Memory of Alarm feature).

LEAVE IMMEDIATELY, and CONTACT THE POLICE from a nearby safe location.

WHEN SAFE TO DO SO, re-enter

and follow the procedure for silencing an alarm.

The **OFF** key is used to disarm the system and to silence alarm and trouble sounds.

To Disarm the System

Enter your **security code** and press the **OFF** key. The "Ready" message will be displayed, and the keypad will emit a single tone to confirm that the system is disarmed.

To Silence a Burglary Alarm

SEE IMPORTANT NOTE AT LEFT!

Enter your **security code** and press the **OFF** key to silence the alarm (or warning tones of a Memory of Alarm). Note the zone in alarm on the keypad display, and make that zone intact (close door, window, etc.). Now enter the security code plus OFF sequence again to clear the keypad's Memory of Alarm display. If the display will not clear and does not provide a "Ready" message, notify the alarm agency.

To Silence a Fire Alarm simply press the **OFF** key (the security code is not needed to silence FIRE alarms). To then clear the keypad's Memory of Alarm display, enter your security code and press the OFF key.

See page 29 for additional fire alarm information.

**See the SUMMARY OF AUDIBLE/VISUAL NOTIFICATION section for information which will help you to distinguish between FIRE (Interrupted/Pulsed) and BURGLARY (Continuous/Steady) alarm sounds.**

## USING THE KEYSWITCH

**General** Your system may be equipped with a keyswitch for use when arming and disarming. A single red light on the keyswitch plate indicates the status of your system as follows:

OFF = Disarmed, Not Ready for Arming

SLOW FLASHING = Disarmed, Ready for Arming

RAPID FLASHING = Armed STAY or AWAY

**Arming** **To arm in the AWAY mode**, turn key to right for 1/2 second.

**To arm in the STAY mode**, hold key turned to right for more than one second.

The keypads will beep twice (AWAY mode) or 3 times (STAY mode) and the keyswitch light will flash rapidly.

**Disarming** **To disarm the system** turn the key to the right and release.

If an alarm has occurred during the armed period, the keyswitch's light will not flash on disarming (thus indicating memory of an alarm). Turning the keyswitch key to the right a second time after disarming can clear the alarm from memory, but it is advisable, instead, to refer to a keypad to diagnose and clear any problem, and to subsequently clear alarm memory. *See the previous page for more about alarm memory.*

## CHIME MODE

### Using the 9 CHIME Key

This feature can be used only while the burglary system is disarmed.

Your system can be set to alert you to the opening of a door or window while it is disarmed by using CHIME mode. When activated, three tones will sound at the keypad whenever a protected door or window is opened. Pressing the **READY** key will display the open points.

**To turn Chime Mode on**, enter the security code and press the **CHIME** key. The CHIME message will appear.

**To turn Chime Mode off**, enter the security code and press the **CHIME** key again. The CHIME message will disappear.

---

## PANIC KEYS

### Using Panic Keys (for manually activating silent and/or audible alarms)

#### TO INITIATE A PANIC FUNCTION AT ANY TIME OF DAY OR NIGHT:

Press an active lettered key  
for at least two seconds.

or

Press both keys of an active  
pair at the same time.

Your system may have been programmed to use special keys or combinations of keys to manually activate emergency (panic) functions. The functions that might be programmed are: Silent Emergency, Audible Emergency, Personal Emergency, and Fire.

**A silent emergency** will send a silent alarm signal to the central station, but there will be no audible alarms or visual displays.

**An audible emergency** will sound a loud, steady alarm at your keypad(s) and at any external sounders that may be connected (ALARM plus a zone number would also be displayed).

**A personal emergency** alarm will send an emergency message to the central station (if connected) and will sound at keypad(s), but not at external bells or sirens.

**A fire alarm** will send a fire alarm message to the central station and will uniquely sound at keypad(s) and external bells and sirens (FIRE plus a zone number would also be displayed).

(continued)

## PANIC KEYS

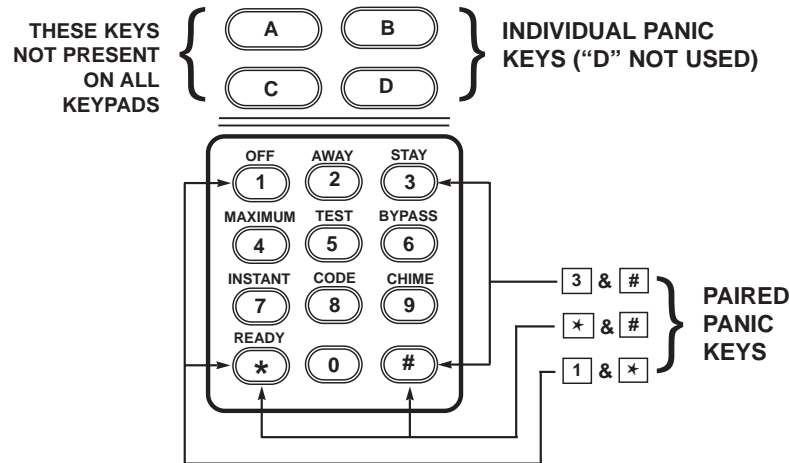

SEE YOUR INSTALLER  
AND NOTE HERE  
THE KEY(S) & FUNCTION(S)  
PROGRAMMED  
FOR YOUR SYSTEM

CHECK IF ACTIVE	PANIC KEY(S)	PROGRAMMED FUNCTION	ZONE NUMBER
<input type="checkbox"/>	[A]	SILENT EMERGENCY (Fixed-Function)	95
<input type="checkbox"/>	[B]	___ SILENT, ___ AUDIBLE, ___ PERSONAL, ___ FIRE	07
<input type="checkbox"/>	[C]	AUDIBLE EMERGENCY (Fixed-Function)	96
OR			
<input type="checkbox"/>	[1] & [*]	SILENT EMERGENCY (Fixed-Function)	95
<input type="checkbox"/>	[*] & [#]	___ SILENT, ___ AUDIBLE, ___ PERSONAL, ___ FIRE	07
<input type="checkbox"/>	[3] & [#]	AUDIBLE EMERGENCY (Fixed-Function)	96

• KEYS [A], [B], AND [C] ARE NOT PRESENT ON ALL KEYPADS.

• KEY [D], IF PRESENT ON YOUR KEYPAD, IS NOT ACTIVE HERE.

# TESTING THE SYSTEM

## TO BE CONDUCTED WEEKLY

### Using the 5 TEST Key

NO ALARM REPORTS  
WILL BE SENT TO THE  
CENTRAL MONITORING  
STATION while the  
system is in Test mode.

The **TEST** key puts your system into Test mode, which allows each protection point to be checked for proper operation.

1. Disarm the system and close all protected windows, doors, etc. The keypad's READY message should be displayed and the READY indicator (if present) should be lit.
2. Enter your security code and press the **TEST** key.
3. The keypad will sound a single beep every 40 seconds as a reminder that the system is in the test mode.

Each time a protection zone is faulted, the external siren or bell should sound for one second and then turn off, while the keypad sounds 3 beeps. *If this does not happen, call for service immediately.*

4. Open and close each protected door and window in turn and listen for the required sounds. The identification of each faulted protection point should appear on the display.
5. Walk in front of any interior motion detectors (if used) and listen for the required sound as movement is detected. The identification of the detector should appear on the display when it is activated.

**Note:** Wireless PIR (Passive Infrared) units will send signals out only if they have been inactive for 3 minutes.



(continued)

## **TESTING THE SYSTEM**

6. Follow the manufacturer's instructions to test all smoke detectors, to ensure that all are functioning properly. The identification of each detector should appear on the display when each is activated.
7. After all protection points have been checked and restored, there should be no zone identification numbers displayed. **If a problem is experienced with any protection point (no confirming sounds, no display), CALL FOR SERVICE IMMEDIATELY.**
8. Turn off the Test mode by entering the security code and pressing the **OFF** key.

## TROUBLE CONDITIONS

### "Check" and "Battery" Displays

The word **CHECK** on the keypad's display, accompanied by a "beeping" at the keypad, indicates a trouble condition in the system.

**To silence the beeping for these conditions, press any key.**

1. **A display of "CHECK" and one or more zone numbers** indicates that a problem exists with the displayed zone(s) and requires your attention. **If the CHECK display relates to a fire zone, CALL FOR SERVICE IMMEDIATELY.**

Determine if the zone(s) displayed are intact and make them so if they are not. If the problem has been corrected, the display can be cleared if you enter the OFF sequence (user code plus OFF key) twice. **If the display persists, CALL FOR SERVICE IMMEDIATELY.**

† Not all systems use wireless sensors.

2. **If there are wireless sensors<sup>†</sup> in your system,** the **CHECK** condition may also be caused by some change in the environment that prevents the receiver from hearing a particular sensor. **CALL FOR SERVICE IMMEDIATELY if this occurs.**

(continued)

## **TROUBLE CONDITIONS**

3. **A display of "BAT" with no zone number or beeping** indicates that the main standby battery in your control is weak. **If this condition persists for more than one day (with AC present), CALL FOR SERVICE.**
4. **A display of "BAT" with a zone number and a once per 40 seconds "beeping" at the keypad** indicates that a low battery condition exists in the wireless sensor displayed. **Either replace the battery yourself, or CALL FOR SERVICE.** If the battery is not replaced within 30 days, a **CHECK** display may occur.

**Power Failure** **If there is no keypad display at all, and the POWER indicator (if present) is not lit,** operating power for the system has stopped and the system is inoperative. **CALL FOR SERVICE IMMEDIATELY.**

**If the message "AC LOSS" or "NO AC" is displayed, and the POWER indicator (if present) is off,** the keypad is operating on battery power only. If only some lights are out on the premises, check circuit breakers and fuses and reset or replace as necessary. **CALL FOR SERVICE IMMEDIATELY if AC power cannot be restored.**

(continued)

## **TROUBLE CONDITIONS**

### **Other Displays**

- dl:** If this remains displayed for more than 1 minute, your system is disabled. **CALL FOR SERVICE IMMEDIATELY.**
- CC:** The system is in communication with the central station for change of function or status verification. **If this message persists for more than 10 minutes, CALL YOUR SERVICE COMPANY.**
- FC:** A communication failure has occurred. **CALL FOR SERVICE IMMEDIATELY.**
- OC** The keypad is not receiving signals from the control panel and sees an open circuit. *If this message persists for more than 10 minutes, CALL YOUR SERVICE COMPANY.*

**FOR SERVICING INFORMATION,  
SEE PAGE 43**

## **FIRE ALARM SYSTEM IF INSTALLED**

**General** Your fire alarm system (if installed) is on 24 hours a day, for continuous protection. In the event of an emergency, the strategically located smoke and heat detectors will automatically send signals to your system, triggering a loud, interrupted sound from the keypad. An interrupted sound will also be produced by optional exterior sounders. A FIRE message will appear at your keypad and remain on until you silence the alarm.

- In Case Of Fire Alarm**
1. Should you become aware of a fire emergency before your detectors sense the problem, go to your nearest keypad and manually initiate an alarm by pressing the panic key pair assigned as FIRE emergency (if programmed by the installer) as indicated on page 23.
  2. Evacuate all occupants from the premises.
  3. If flames and/or smoke are present, leave the premises and notify your local Fire Department immediately.
  4. If no flames or smoke are apparent, investigate the cause of the alarm. The zone number(s) of the zone(s) in an alarm condition will be displayed at the keypad.

### **TYPICAL FIRE EMERGENCY DISPLAY**



(continued)

## **FIRE ALARM SYSTEM IF INSTALLED**

- Silencing Fire Alarms**
1. Silence the alarm by pressing the **OFF** key (security code not needed to silence fire alarms). To clear the display, enter your code and press the **OFF** key again (Memory of Alarm).
  2. If the keypad does not indicate a **READY** condition after the second **OFF** sequence, press the **READY** key to display the zone(s) that are faulted. Be sure to check that smoke detectors are not responding to smoke or heat producing objects in their vicinity. Should this be the case, eliminate the source of heat or smoke.
  3. If this does not remedy the problem, there may still be smoke in the detector. Clear it by fanning the detector for about 30 seconds.
  4. When the problem has been corrected, clear the display by entering your code and pressing the **OFF** key.

# NATIONAL FIRE PROTECTION ASSOCIATION RECOMMENDATIONS ON SMOKE DETECTORS

## General

With regard to the number and placement of smoke/heat detectors, we subscribe to the recommendations contained in the National Fire Protection Association's Standard #74 noted below.

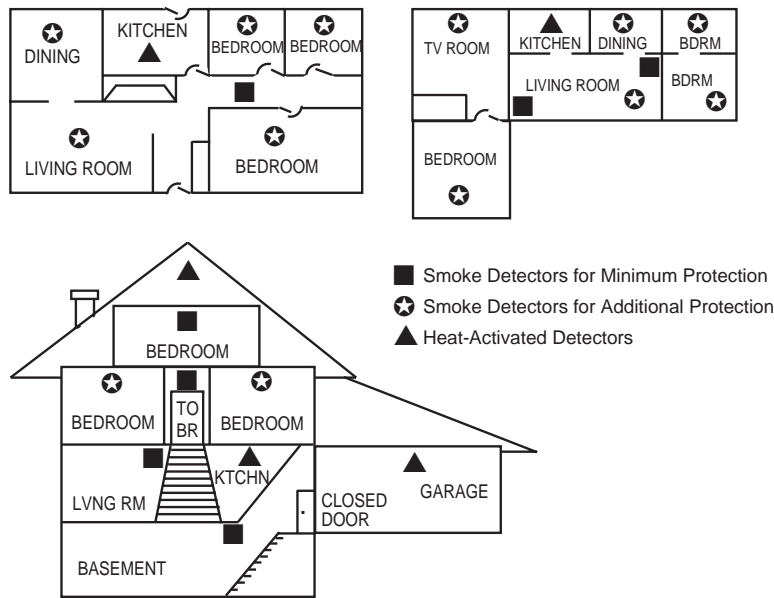

Early warning fire detection is best achieved by the installation of fire detection equipment in all rooms and areas of the premises as follows: A smoke detector installed outside of each separate sleeping area, in the immediate vicinity of the bedrooms and on each additional story of the family living unit, including basements and excluding crawl spaces and unfinished attics.

In addition, it is recommended that the owner consider the use of heat or smoke detectors in the living room, dining room, bedroom(s), kitchen, hallway(s), attic, furnace room, utility and storage rooms, basements and attached garages.

# EMERGENCY EVACUATION

## Steps to Safety

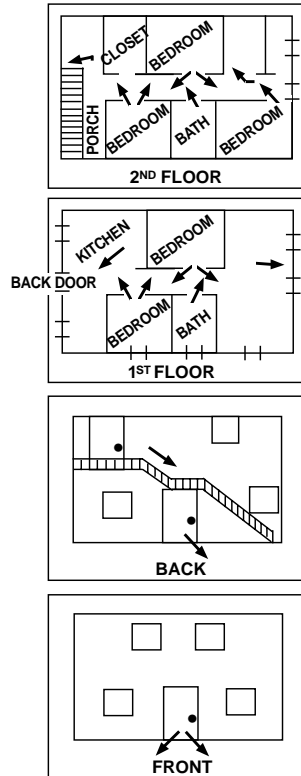

Establish and regularly practice a plan of escape in the event of fire. The following steps are recommended by the National Fire Protection Association:

1. Plan on your detector or your interior and/or exterior sounders warning all occupants.
2. Determine two means of escape from each room. One path of escape should lead to the door that permits normal exit from the building. The other may be a window, should your path be unpassable. Station an escape ladder at such windows if there is a long drop to the ground.
3. Sketch a floor plan of the building. Show windows, doors, stairs and rooftops that can be used to escape. Indicate escape routes for each room. Keep these routes free from obstruction and post copies of the escape routes in every room.
4. Assure that all bedroom doors are shut while you are asleep. This will prevent deadly smoke from entering while you escape.
5. Try the door. If the door is hot, check your alternate escape route. If the door is cool, open it cautiously. Be prepared to slam the door if smoke or heat rushes in.
6. In smoky areas, crawl close to floor, hold your breath, and/or cover mouth and nose with a wet cloth.
7. Escape quickly; don't panic.
8. Establish a common meeting place outdoors, away from your premises, where everyone can meet and then take steps to contact the authorities and account for those missing. Choose someone to assure that nobody returns to the premises — many die going back.



## QUICK GUIDE TO ALARM SYSTEM FUNCTIONS

FUNCTION	PROCEDURE	COMMENTS
<b>Check Zones</b>	Press READY key.	To view faulted zones when system not ready.
<b>Arm System</b>	Enter code. Press arming key desired: (AWAY, STAY, INSTANT, MAXIMUM)	Arms system in mode selected.
<b>Quick Arm (if programmed)</b>	Press #. Press arming key desired: (AWAY, STAY, INSTANT, MAXIMUM)	Arms system in mode selected, quickly and without use of code.
<b>Bypass Zone(s)</b>	Enter code. Press BYPASS key. Enter zone number(s) to be bypassed (use 2-digit entries).	Bypassed zones are unprotected and will not cause an alarm if violated.
<b>Quick Bypass (if programmed)</b>	Enter code. Press BYPASS key.	Bypasses all faulted zones automatically.
<b>Silence Sounders</b> <b>Burglary:</b> <b>Fire:</b> <b>"Check":</b>	Enter code. Press OFF key. Press OFF key. Press any key.	Also disarms system. Memory of alarm remains until cleared. Memory of Alarm remains until cleared. Determine cause. See Page 26.
<b>Disarm System</b>	Enter code. Press OFF key.	Also silences sounders. Memory of alarm remains until cleared.
<b>Clear Alarm Memory</b>	After disarming, enter code again. Press OFF key again.	Keypad will beep rapidly upon entry if alarm has occurred. Alarm display will remain upon disarming until cleared.
<b>Duress (if connected to central station)</b>	Enter user code 8 to arm or disarm "normally."	Performs desired action and sends silent alarm to central station.
<b>Panic Alarms (as programmed)</b>	Press key [A], [B], or [C] for at least 2 sec., or (if no A, B, or C on your keypad) press keys [1]&[*], or [*]&[#], or [3]&[#], both at same time.	See Page 23 for functions programmed for your system.
<b>Chime Mode</b>	<i>To turn ON or OFF:</i> Enter code. Press CHIME key.	Keypad will sound if doors or windows are violated while system is disarmed and chime mode is ON.
<b>Test Mode</b>	<i>To turn ON:</i> Enter code. Press TEST key. <i>To turn OFF:</i> Enter code. Press OFF key.	Tests alarm sounder and allows sensors to be tested.

## SUMMARY OF AUDIBLE/VISUAL NOTIFICATIONS

SOUND	CAUSE	DISPLAY
LOUD, INTERRUPTED† Keypad & External	FIRE ALARM	<b>FIRE</b> and <b>ALARM</b> are displayed; protection zone in alarm is displayed.
LOUD, CONTINUOUS† Keypad & External	BURGLARY/AUDIBLE EMERGENCY ALARM	<b>ALARM</b> is displayed; protection zone in alarm is also displayed.
ONE SHORT BEEP (not repeated) Keypad only	a. SYSTEM DISARM b. SYSTEM ARMING ATTEMPT WITH AN OPEN ZONE c. BYPASS VERIFY	a. Only <b>READY</b> is displayed. Green READY indicator (if present) is lit. b. <b>NOT READY</b> is displayed, open protection zone number is displayed. Green READY indicator (if present) is not lit. c. The bypassed protection zone numbers are displayed. (One beep for each number displayed.) <b>BYPASS</b> also displayed.
ONE SHORT BEEP (once every 40 seconds) Keypad only	SYSTEM IS IN TEST MODE	Opened Zone identifications will appear.
ONE BEEP every 40 sec. Keypad only	a. LOW BATTERY AT XMTR b. TROUBLE	a. <b>BAT</b> displayed with ID number of transmitter. b. <b>CHECK</b> displayed. Troubled protection zone is displayed.
TWO SHORT BEEPS Keypad only	ARM AWAY OR MAXIMUM	<b>AWAY</b> and (if MAXIMUM) <b>INSTANT</b> are displayed.
THREE SHORT BEEPS Keypad only	a. ARM STAY OR INSTANT b. ZONE OPENED WHILE SYS- TEM IS IN CHIME MODE c. ZONE OPENED WHILE SYS- TEM IS IN TEST MODE	a. <b>STAY</b> and (if INSTANT) <b>INSTANT</b> are displayed. Red ARMED indicator is lit. b. <b>CHIME</b> displayed. Pressing */ READY key will display opened zone. c. Open protection zone number is displayed.
RAPID BEEPING Keypad only	MEMORY OF ALARM	<b>FIRE</b> and/or <b>ALARM</b> is displayed; zone in alarm is displayed.
SLOW BEEPING Keypad only	ENTRY DELAY WARNING	None during delay; Exceeding the delay time without disarming causes alarm.

†If bell is used as external sounder, fire alarm is pulsed ring; burglary/audible emergency is steady ring.

**Notes:**

- **BAT** displayed (with no beeping or zone number) indicates system main battery is weak (see page 27).
- Also see *Power Failure*, and *Other Displays* under **TROUBLE CONDITIONS** on page 27.

## PROTECTION ZONES LIST

One or more sensing devices will have been assigned by the installer of your alarm system to each of the various protection zones in your system (*although not every zone number can be used*). For example, the sensing device on your Entry/Exit door may have been assigned to zone 06, sensing devices on windows in the master bedroom to zone 10, and so on.

Zone numbers 07, 95 and 96 represent keypad "Panic" alarm functions assigned by the installer (see Page 23). Zone numbers 08 and 09 are reserved for Duress and Tamper signal reporting to the central station.

This chart may be used to record the specific zone number assignments for your system. Your installer will assist you in recording this information.

### PROTECTION ZONE DESCRIPTIONS

Zone	Description	Zone	Description	Zone	Description	Zone	Description
01		17		34		51	
02		18		35		52	
03		19		36		53	
04		20		37		54	
05		21		38		55	
06		22		39		56	
07	Key B (or: * & #) Panic	23		40		57	
		24		41		58	
08	-Duress-	25		42		59	
09	-Tamper-	26		43		60	
10		27		44		61	
11		28		45		62	
12		29		46		63	
13		30		47		95	Key A (or 1 & *) Panic
14		31		48			
15		32		49		96	Key C (or 3 & #) Panic
16		33		50			

**- NOTES -**

## OWNER'S INSURANCE PREMIUM CREDIT REQUEST

This form should be completed and forwarded to your homeowner's insurance carrier for possible premium credit.

**A. GENERAL INFORMATION:**

Insured's Name and Address: \_\_\_\_\_  
\_\_\_\_\_

Insurance Company: \_\_\_\_\_ Policy No.: \_\_\_\_\_

First Alert System: FA120C

Type of Alarm:  Burglary  Fire  Both

Installed by: \_\_\_\_\_ name \_\_\_\_\_ name  
\_\_\_\_\_ address \_\_\_\_\_ address

**B. NOTIFIES (Insert B for Burglary, F for Fire, where appropriate):**

Local Sounding Device \_\_\_\_\_ Police Dept. \_\_\_\_\_ Fire Dept. \_\_\_\_\_ Central Station \_\_\_\_\_

Name and Address: \_\_\_\_\_

**C. POWERED BY:** A.C. With Rechargeable Power Supply

**D. TESTING:**  Quarterly,  Monthly,  Weekly,  Other \_\_\_\_\_

continued on other side

**OWNER'S INSURANCE PREMIUM  
CREDIT REQUEST (cont.)**

**E. SMOKE DETECTOR LOCATIONS:**

- |                                       |                                      |                                      |                                |
|---------------------------------------|--------------------------------------|--------------------------------------|--------------------------------|
| <input type="checkbox"/> Furnace Room | <input type="checkbox"/> Kitchen     | <input type="checkbox"/> Bedrooms    | <input type="checkbox"/> Attic |
| <input type="checkbox"/> Basement     | <input type="checkbox"/> Living Room | <input type="checkbox"/> Dining Room | <input type="checkbox"/> Hall  |

**F. BURGLARY DETECTING DEVICE LOCATIONS:**

- |   |  |   |   |
|---|--|---|---|
| <input type="checkbox"/> Front Door   | <input type="checkbox"/> Basement Door | <input type="checkbox"/> Rear Door          | <input type="checkbox"/> All Exterior Doors |
| <input type="checkbox"/> 1st Floor Windows  | <input type="checkbox"/> All windows   | <input type="checkbox"/> Interior Locations |   |
| <input type="checkbox"/> All Accessible Openings, Including Skylights, Air Conditioners and Vents |  |   |   |

**G. ADDITIONAL PERTINENT INFORMATION:**

---

---

---

---

Signature: \_\_\_\_\_ Date: \_\_\_\_\_

## CANADIAN DEPARTMENT OF COMMUNICATIONS (DOC) STATEMENT

### NOTICE

The Canadian Department of Communications label identifies certified equipment. This certification means that the equipment meets certain telecommunications network protective, operational and safety requirements. The Department does not guarantee the equipment will operate to the user's satisfaction.

Before installing this equipment, users should ensure that it is permissible to be connected to the facilities of the local telecommunications company. The equipment must also be installed using an acceptable method of connection. In some cases, the company's inside wiring associated with a single line individual service may be extended by means of certified connector assembly (telephone extension cord). The customer should be aware that compliance with the above conditions may not prevent degradation of service in some situations.

Repairs to certified equipment should be made by an authorized Canadian maintenance facility designated by the supplier. Any repairs or alterations made by the user to this equipment, or equipment malfunctions, may give the telecommunications company cause to request the user to disconnect the equipment.

Users should ensure for their own protection that the electrical ground connections of the power utility, telephone lines and internal metallic water pipe system, if present, are connected together. This precaution may be particularly important in rural areas.

**Caution:** User should not attempt to make such connections themselves, but should contact the appropriate electric inspection authority, or electrician, as appropriate.

The Load Number (LN) assigned to each terminal device denotes the percentage of the total load to be connected to a telephone loop which is used by the device, to prevent overloading. The termination on a loop may consist of any combination of devices subject only to the requirement that the total of the Load Numbers of all the devices does not exceed 100.

### AVIS

L'étiquette du ministère des Communications du Canada identifie le matériel homologué. Cette étiquette certifie que le matériel est conforme à certaines normes de protection, d'exploitation et de sécurité des réseaux de télécommunications. Le ministère n'assure toutefois pas que le matériel fonctionnera à la satisfaction de l'utilisateur.

Avant d'installer ce matériel, l'utilisateur doit s'assurer qu'il est permis de le raccorder aux installations de l'entreprise locale de télécommunications. Le matériel doit également être installé en suivant une méthode acceptée de raccordement. Dans certains cas, les fils intérieurs de l'entreprise utilisés pour un service individuel à la ligne unique peuvent être prolongés au moyen d'un dispositif homologué de raccordement (cordon prolongateur téléphonique interne). L'abonné ne doit pas oublier qu'il est possible que la conformité aux conditions énoncées ci-dessus n'empêche pas la dégradation du service dans certaines situations. Actuellement, les entreprises de télécommunications ne permettent pas que l'on raccorde leur matériel aux prises d'abonnés, sauf dans les cas précis prévus par les tarifs particuliers de ces entreprises.

Les réparations du matériel homologué doivent être effectuées pas un centre d'entretien canadien autorisé désigné par le fournisseur. La compagnie de télécommunications peut demander à l'utilisateur de débrancher un appareil à la suite de réparations ou de modifications effectuées par l'utilisateur ou à cause de mauvais fonctionnement.

Pour sa propre protection, l'utilisateur doit s'assurer que tous les fils de mise en terre de la source d'énergie électrique, des lignes téléphoniques de réseau de conduites d'eau, s'il y en a, soient raccordés ensemble. Cette précaution est particulièrement importante dans les régions rurales.

**Avertissement:** L'utilisateur ne doit pas tenter de faire ces raccordements lui-même; il doit avoir recours à un service d'inspection des installations électriques, ou à un électricien, selon le cas.

L'indice de charge (IC) assigné à chaque dispositif terminal pour éviter toute surcharge indique le pourcentage de la charge totale qui peut être raccordé à un circuit téléphonique fermé utilisé par ce dispositif. La terminaison du circuit fermé peut être constituée de n'importe quelle combinaison de dispositifs, pourvu que la somme des indices de charge de l'ensemble des dispositifs ne dépasse pas 100.

## UL NOTICE: This is a "Grade A" Residential System.

### FEDERAL COMMUNICATIONS COMMISSION (FCC) Part 15 STATEMENT

This equipment has been tested to FCC requirements and has been found acceptable for use. The FCC requires the following statement for your information:

This equipment generates and uses radio frequency energy and if not installed and used properly, that is, in strict accordance with the manufacturer's instructions, may cause interference to radio and television reception. It has been type tested and found to comply with the limits for a Class B computing device in accordance with the specifications in Part 15 of FCC Rules, which are designed to provide reasonable protection against such interference in a residential installation. However, there is no guarantee that interference will not occur in a particular installation. If this equipment does cause interference to radio or television reception, which can be determined by turning the equipment off and on, the user is encouraged to try to correct the interference by one or more of the following measures:

- If using an indoor antenna, have a quality outdoor antenna installed.
- Reorient the receiving antenna until interference is reduced or eliminated.
- Move the radio or television receiver away from the receiver/control.
- Move the antenna leads away from any wire runs to the receiver/control.
- Plug the receiver/control into a different outlet so that it and the radio or television receiver are on different branch circuits.

If necessary, the user should consult the dealer or an experienced radio/television technician for additional suggestions. The user or installer may find the following booklet prepared by the Federal Communications Commission helpful:

"Interference Handbook"

This booklet is available from the U.S. Government Printing Office, Washington, DC 20402.

*The user shall not make any changes or modifications to the equipment unless authorized by the Installation Instructions or User's Manual. Unauthorized changes or modifications could void the user's authority to operate the equipment.*

### FEDERAL COMMUNICATIONS COMMISSION (FCC) Part 68 STATEMENT

This equipment complies with Part 68 of the FCC rules. On the front cover of this equipment is a label that contains, among other information, the FCC registration number and ringer equivalence number (REN) for this equipment. If requested, this information must be provided to the telephone company.

This equipment uses the following jacks: An RJ31X is used to connect this equipment to the telephone network.

The REN is used to determine the quantity of devices which may be connected to the telephone line. Excessive RENs on the telephone line may result in the devices not ringing in response to an incoming call. In most, but not all areas, the sum of the RENs should not exceed five (5.0). To be certain of the number of devices that may be connected to the line, as determined by the total RENs, contact the telephone company to determine the maximum REN for the calling area. *(continued)*



**(continued) FEDERAL COMMUNICATIONS COMMISSION (FCC) Part 68 STATEMENT**

If this equipment causes harm to the telephone network, the telephone company will notify you in advance that temporary discontinuance of service may be required. If advance notice is not practical, the telephone company will notify the customer as soon as possible. Also, you will be advised of your right to file a complaint with the FCC if you believe necessary.

The telephone company may make changes in its facilities, equipment, operations, or procedures that could affect the operation of the equipment. If this happens, the telephone company will provide advance notice in order for you to make the necessary modifications in order to maintain uninterrupted service.

If trouble is experienced with this equipment, please contact the manufacturer for repair and warranty information. If the trouble is causing harm to the telephone network, the telephone company may request you remove the equipment from the network until the problem is resolved.

There are no user serviceable components in this product, and all necessary repairs must be made by the manufacturer. Other repair methods may invalidate the FCC registration on this product.

This equipment cannot be used on telephone company-provided coin service. Connection to Party Line Service is subject to state tariffs.

This equipment is hearing-aid compatible.

When programming or making test calls to an emergency number, briefly explain to the dispatcher the reason for the call. Perform such activities in the off-peak hours; such as early morning or late evening.

**IN THE EVENT OF TELEPHONE OPERATIONAL PROBLEMS**

If your security system has been connected to the telephone line, and there is trouble with regular telephone service, disconnect the security system from the telephone line by removing the plug from the RJ31X (CA38A in Canada) telephone wall jack (you should have been shown how to do this by your installing company). *Do not attempt to disconnect the telephone line connection inside the control cabinet. Doing so will result in the COMPLETE disruption of your regular telephone service.*

If the regular phone works correctly after the plug has been disconnected from the RJ31X wall jack, the security system has a problem and you should call your service representative for service immediately. If, upon disconnection of the security system from the wall jack, there is *still* a problem with telephone service, notify the telephone company that they have a problem and request prompt repair service.

**IMPORTANT: A security system connected to an alarm monitoring station relies on that connection.**

- If the security system is at fault, reinsert the plug as soon as the security system is repaired.
- If the phone service is at fault, re-insert the plug immediately, to ensure resumption of full protection upon restoration of phone service.

The user may not, under any circumstances (in or out of warranty), attempt any service or repairs to the system.

## **WARNING!**

### **THE LIMITATIONS OF THIS ALARM SYSTEM**

While this system is an advanced design security system, it does not offer guaranteed protection against burglary or fire or other emergency. Any alarm system, whether commercial or residential, is subject to compromise or failure to warn for a variety of reasons. For example:

- Intruders may gain access through unprotected openings or have the technical sophistication to bypass an alarm sensor or disconnect an alarm warning device.
- Intrusion detectors (e.g. passive infrared detectors), smoke detectors, and many other sensing devices will not work without power. Battery operated devices will not work without batteries, with dead batteries, or if the batteries are not put in properly. Devices powered solely by AC will not work if their AC power supply is cut off for any reason, however briefly.
- Signals sent by wireless transmitters may be blocked or reflected by metal before they reach the alarm receiver. Even if the signal path has been recently checked during a weekly test, blockage can occur if a metal object is moved into the path.
- A user may not be able to reach a panic or emergency button quickly enough.
- While smoke detectors have played a key role in reducing residential fire deaths in the United States, they may not activate or provide early warning for a variety of reasons in as many as 35% of all fires, according to data published by the Federal Emergency Management Agency. Some of the reasons smoke detectors used in conjunction with this System may not work are as follows. Smoke detectors may have been improperly installed and positioned. Smoke detectors may not sense fires that start where smoke cannot reach the detectors, such as in chimneys, in walls, or roofs, or on the other side of closed doors. Smoke detectors also may not sense a fire on another level of a residence or building. A second floor detector, for example, may not sense a first floor or basement fire. Moreover, smoke detectors have sensing limitations. No smoke detector can sense every kind of fire every time. In general, detectors may not always warn about fires caused by carelessness and safety hazards like smoking in bed, violent explosions, escaping gas, improper storage of flammable materials, overloaded electrical circuits, children playing with matches, or arson. Depending upon the nature of the fire and/or the locations of the smoke detectors, the detector, even if it operates as anticipated, may not provide sufficient warning to allow all occupants to escape in time to prevent injury or death.
- Passive Infrared Motion Detectors can only detect intrusion within the designed ranges as diagrammed in their installation manual. Passive Infrared Detectors do not provide volumetric area protection. They do create multiple beams of protection, and intrusion can only be detected in unobstructed areas covered by those beams. They cannot detect motion or intrusion that takes place behind walls, ceilings, floors, closed doors, glass partitions, glass doors, or windows. Mechanical tampering, masking, painting or spraying of any material on the mirrors, windows or any part of the optical system can reduce their detection ability. Passive Infrared Detectors sense changes in temperature; however, as the ambient temperature of protected area approaches the temperature range of 90° to 105°F (32° to 40°C), the detection performance can decrease.

*(continued)*

**(continued) WARNING! THE LIMITATIONS OF THIS ALARM SYSTEM**

- Alarm warning devices such as sirens, bells or horns may not alert people or wake up sleepers if they are located on the other side of closed or partly open doors. If warning devices sound on a different level of the residence from the bedrooms, then they are less likely to waken or alert people inside the bedrooms. Even persons who are awake may not hear the warning if the alarm is muffled from a stereo, radio, air conditioner or other appliance, or by passing traffic. Finally, alarm warning devices, however loud, may not warn hearing-impaired people or waken deep sleepers.
- Telephone lines needed to transmit alarm signals from a premises to a central monitoring station may be out of service or temporarily out of service. Telephone lines are also subject to compromise by sophisticated intruders.
- Even if the system responds to the emergency as intended, however, occupants may have insufficient time to protect themselves from the situation. In the case of a monitored alarm system, authorities may not respond appropriately.
- This equipment, like other electrical devices, is subject to component failure. Even though this equipment is designed to last as long as 10 years, the electronic components could fail at any time.

The most common cause of an alarm system not functioning when an intrusion or fire occurs is inadequate maintenance. This alarm system should be tested weekly to make sure all sensors and transmitters are working properly.

Wireless transmitters (used with some systems) are designed to provide long battery life under normal operating conditions. Longevity of batteries may be as much as 4 to 7 years, depending on the environment, usage, and the specific wireless device being used. External factors such as humidity, high or low temperatures, as well as large swings in temperature, may all reduce the actual battery life in a given installation. This wireless system, however, can identify a true low battery situation, thus allowing time to arrange a change of battery to maintain protection for that given point within the system.

Installing an alarm system may make one eligible for lower insurance rates, but an alarm system is not a substitute for insurance. Homeowners, property owners and renters should continue to act prudently in protecting themselves and continue to insure their lives and property.

We continue to develop new and improved protection devices. Users of alarm systems owe it to themselves and their loved ones to learn about these developments.

**SERVICING INFORMATION**

Your local authorized service representative is the person best qualified to service your alarm system. Arranging a regular program with that person is advisable. Your local service representative is:

NAME: \_\_\_\_\_ PHONE: \_\_\_\_\_

ADDRESS: \_\_\_\_\_

\_\_\_\_\_

### **ONE YEAR LIMITED WARRANTY**

Pittway Corporation, and its divisions, subsidiaries and affiliates ("Seller"), 165 Eileen Way, Syosset, New York 11791, warrants its First Alert security equipment (the "product") to be free from defects in materials and workmanship for one year from date of original purchase, under normal use and service. Seller's obligation is limited to repairing or replacing, at its option, free of charge for parts, labor, or transportation, any product proven to be defective in materials or workmanship under normal use and service. Seller shall have no obligation under this warranty or otherwise if the product is altered or improperly repaired or serviced by anyone other than the Seller. In case of defect, contact the security professional who installed and maintains your security equipment or the Seller for product repair.

This one year Limited Warranty is in lieu of all other express warranties, obligations or liabilities. THERE ARE NO EXPRESS WARRANTIES, WHICH EXTEND BEYOND THE FACE HEREOF. ANY IMPLIED WARRANTIES, OBLIGATIONS OR LIABILITIES MADE BY SELLER IN CONNECTION WITH THIS PRODUCT, INCLUDING ANY IMPLIED WARRANTY OF MERCHANTABILITY, OR FITNESS FOR A PARTICULAR PURPOSE OR OTHERWISE, ARE LIMITED IN DURATION TO A PERIOD OF ONE YEAR FROM THE DATE OF ORIGINAL PURCHASE. ANY ACTION FOR BREACH OF ANY WARRANTY, INCLUDING BUT NOT LIMITED TO ANY IMPLIED WARRANTY OF MERCHANTABILITY, MUST BE BROUGHT WITHIN 12 MONTHS FROM DATE OF ORIGINAL PURCHASE. IN NO CASE SHALL SELLER BE LIABLE TO ANYONE FOR ANY CONSEQUENTIAL OR INCIDENTAL DAMAGES FOR BREACH OF THIS OR ANY OTHER WARRANTY, EXPRESS OR IMPLIED, OR UPON ANY OTHER BASIS OF LIABILITY WHATSOEVER, EVEN IF THE LOSS OR DAMAGE IS CAUSED BY THE SELLER'S OWN NEGLIGENCE OR FAULT. Some states do not allow limitation on how long an implied warranty lasts or the exclusion or limitation of incidental or consequential damages, so the above limitation or exclusion may not apply to you.

Seller does not represent that the product may not be compromised or circumvented; that the product will prevent any personal injury or property loss by burglary, robbery, fire or otherwise; or that the product will in all cases provide adequate warning or protection. Buyer understands that a properly installed and maintained alarm may only reduce the risk of a burglary, robbery, fire or other events occurring without providing an alarm, but it is not insurance or a guarantee that such will not occur or that there will be no personal injury or property loss as a result. CONSEQUENTLY, SELLER SHALL HAVE NO LIABILITY FOR ANY PERSONAL INJURY, PROPERTY DAMAGE OR OTHER LOSS BASED ON A CLAIM THE PRODUCT FAILED TO GIVE WARNING. HOWEVER, IF SELLER IS HELD LIABLE, WHETHER DIRECTLY OR INDIRECTLY, FOR ANY LOSS OR DAMAGE ARISING UNDER THIS LIMITED WARRANTY OR OTHERWISE, REGARDLESS OF CAUSE OR ORIGIN, SELLER'S MAXIMUM LIABILITY SHALL NOT IN ANY CASE EXCEED THE PURCHASE PRICE OF THE PRODUCT, WHICH SHALL BE THE COMPLETE AND EXCLUSIVE REMEDY AGAINST SELLER. This warranty gives you specific legal rights, and you may also have other rights which vary from state to state. No increase or alteration, written or verbal, to this warranty is authorized.



**172 Michael Drive  
Syosset, New York 11791**  
COPYRIGHT © 1996 PITTWAY CORPORATION